

Varenummer: 0118028  
 Beskrivelse: Seeger låsering H 13

## Mål

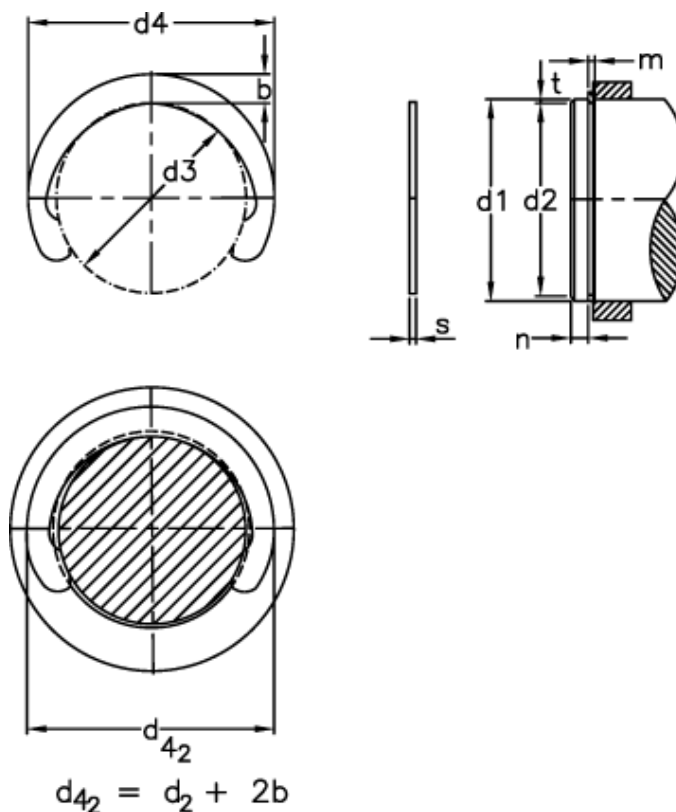

b	= 2.00	FRg kN	= 2.0	t	= 0.60
Betegnelse	= H 13,0	FR kN	= 4.50	tol	= -0.11
d1	= 13	g	= 1.00	tol	= 0.18
d2	= 11.8	Griber	= GRH 13	tol	= -0.06
d3	= 11.40	m min	= 1.10	vægt kg/1000	= 0.36
d4	= 15.40	n abl x 1000	= 30		
d4 2	= 15.8	Nominel træk	= 1.8		
FN kN	= 1.90	s	= 1.00		